

The Care and Treatment of Feedback Audio Amplifiers

W. B. BERNARD, CDR., USN*

Anyone who has noticed a lack of stability in his Williamson-type amplifier may have wondered what caused it and how it could be corrected. The author gives the reasons and describes the methods taken to eliminate the troubles.

INVERSE OR NEGATIVE FEEDBACK has become widely accepted in the design of audio amplifiers. It may safely be said that it is incorporated in all output amplifiers of quality manufactured at the present time. This widespread use results from the benefits that can be produced by its application. This discussion will be limited mainly to the application of inverse voltage feedback to audio amplifiers. This type of feedback acts to reduce the output impedance of an amplifier in addition to reducing the distortion and noise produced. It also extends the frequency response of the amplifier.

The gain of an amplifier with voltage feedback is given by the equation $A_f = \frac{A}{1 - BA}$, where A is the raw gain of the amplifier (gain in the absence of feedback), and B is the percentage of the output voltage that is fed back. Distortion is reduced by the same proportion and, if the input signal is increased to make up for the loss of gain, the noise introduced by the amplifier is also reduced by the same factor. The loss of gain is a small price to pay for the benefits derived since voltage gain is easily obtained.

The output impedance of an amplifier with inverse voltage feedback is given by the equation $Z_f = \frac{R_p}{1 - \mu BA_f}$. R_p is the plate resistance of the output tube, μ is the amplification factor of the output tube, B is the portion of the output voltage fed back, and A_f is the amplification of the amplifier between the point where the feedback voltage is inserted and the grid of the output tube. In the case of pentodes and tetrodes where μ may be up to 200 or 300 it can be seen that a very small amount of feedback will give a tremendous reduction of output impedance. Figure 1 shows the result of applying 1/15 of the output of a 6L6 to the grid of the tube. The plate resistance is reduced from about 25,000 ohms

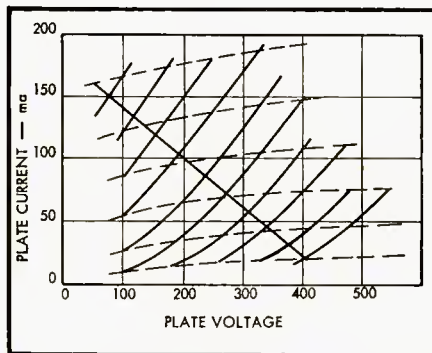

Fig. 1. Typical plate family of a 6L6 with 1/15 of its output fed back to the input.

to less than 2000 ohms. Observation of the curves will show that the power-output capabilities of the tube have not been diminished and a comparison with curves for a triode-connected 6L6 will show that it is much more linear, and regardless of the load placed on the tube the tetrode with inverse feedback has superior characteristics. Inverse feedback applied to the triode will make the plate characteristics more linear but they can do nothing to increase the power capabilities of the tube.

In practice the amount of feedback that is needed to reduce distortion reduces the output impedance to a satisfactory value. There are opinions which diverge from this view but they are seemingly in the minority and are divided between those who think that the usual amount of voltage feedback does not sufficiently reduce the impedance, and those who think that it reduces the impedance too much. From the standpoint of standardization both of these views create difficulties because it seems that all that is reasonable to expect of a speaker manufacturer is that he will strive to produce a speaker which will give a uniform acoustic output over a given frequency range when the speaker is furnished a uniform voltage input.

If we are satisfied that the amount of inverse voltage feedback which we are going to apply will give us a usable output impedance—one fifth of the load

impedance or less—we may eliminate the consideration of over-all current feedback and the additional complications which it entails. We may still make use of negative current feedback inside the main feedback loop by such means as unbypassed cathode resistors. Having decided that negative voltage feedback is what we need in our amplifier we must consider how much we need and how we should apply it.

Feedback Methods

We may say that reducing the distortion to 1 per cent IM just before we drive the output grids to clipping level is a reasonable standard for high fidelity purposes. There may be some argument with this standard, but it is very close to what is generally realized in the better amplifiers today. In the usual circuits this calls for about 20 db of inverse feedback. In a properly designed amplifier the major portion of the distortion will be produced in the output stage; therefore, any useful feedback system will include the output stage. Internal feedback loops which do not include the output tubes should not be counted as being effective in reducing the total distortion. Such figures are most useful for advertising purposes.

At this point we may mention briefly two other feedback systems. The output

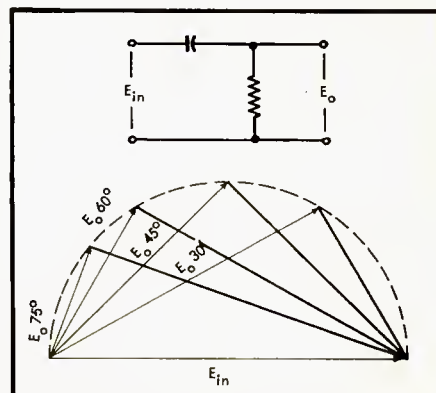

Fig. 2. Typical coupling circuit with one time constant and its circle diagram showing phase shift.

* U. S. Naval Electronics Laboratory, San Diego, Calif.

tube cathodes are sometimes returned to the ends of a secondary or tertiary winding on the output transformer which is so phased that the voltages produced in this winding oppose the grid to cathode signal voltages. This connection is very effective in reducing distortion and output impedance, but has the disadvantage that special output transformers are required. It is generally used with some type of over-all feedback system because if over 6 to 10 db of feedback is applied by this method the voltage required from the driver stage becomes difficult to furnish without encountering appreciable distortion in the driver stage.

The screen grids of the output tubes may be tapped up on the primary of the output transformer in the Ultra-Linear connection. This connection slightly reduces the output power available from a given set of tubes for a specified voltage supply condition, but it also allows the screen voltage to be increased so that this loss in power output capabilities may be recovered. This system is also usually used with some over-all feedback system since only 5 or 6 db of feedback may be applied thereby, and because it does not reduce distortion by the same factor that it reduces gain. It is useful, however, to reduce the output impedance of the tubes at very high frequencies when phase shifts in other parts of the circuit reduce the effectiveness of the over-all feedback loop for this purpose. This connection also requires a special transformer and such transformers are now available at about the same price as equivalent transformers without the screen taps.

Over-all voltage feedback is customarily obtained from the plates of the output tubes or from the secondary of the output transformer. Although some commercial amplifiers have been produced which take the feedback voltages from the plates of the output tubes, such systems have very serious disadvantages. First they do not remedy any defects in the output transformer response or distortion characteristics. Second, they place severe requirements upon the power-supply filtering and the balance between the halves of the primary of the output transformer if they are not to increase the hum in the output of the amplifier. This situation results because such a system acts to reduce, at the plates of the output tubes, any signal that is not present in the amplifier ahead of where the feedback voltage is introduced. If there is any hum voltage present at the center tap of the output transformer, the feedback will act to reduce the amount of hum at the plates of the tubes to less than the amount at the center. Therefore, there will be hum currents flowing in the halves of the output-transformer primary. These currents are out of phase but even so they will pro-

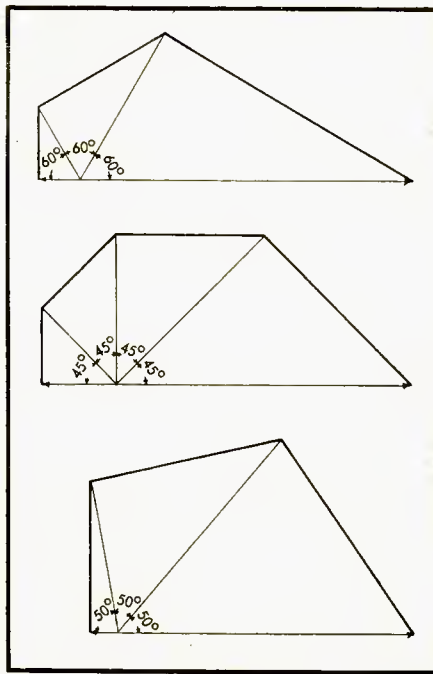

Fig. 3. Circle diagrams for circuits having more than one time constant within the feedback loop.

duce a voltage in the secondary of the transformer unless the currents are equal and the halves of the transformer primary are exactly balanced.

A special case of feedback is the connection of a network from the plate to the grid of a single stage. Such a system does not reduce the gain of the stage around which it is connected but reduces the gain of the previous stage by reducing the load resistance into which the previous stage works. Because such a system may offer an abnormally low load to the previous stage it may produce more distortion in the driver stage than it reduces in the output stage. In a high-quality amplifier it should not be used where the signal voltage exceeds a volt or two.

Finally we may consider the system where the feedback voltage is taken from the secondary of the output transformer. This has the advantage that in addition to reducing noise and distortion in the remainder of the amplifier it also reduces the distortion and the variation of frequency response caused by deficiencies of the output transformer. It has the disadvantage that the amount of feedback which can be applied may be more limited by the considerations of stability than is the case when the feedback voltage is taken from the primary of the output transformer.

Possibility of Oscillation

When we previously considered the feedback gain equation we were thinking of the mid-frequency situation where A is positive and B is negative thus making $-AB$ a positive number. At

frequency extremes A is no longer a positive real number. It becomes complex and may lie in any of the four quadrants. B may also change phase and magnitude with frequency. If AB becomes 1 or greater in magnitude and is a positive real number the amplifier will be subject to oscillation.

This situation may be avoided by insuring that the phase shifts around the entire feedback loop do not add up to 180 deg. until the quantity BA is less than one.

The difficulty of achieving the above requirement for stability will depend upon the design of the amplifier. At very low frequencies each RC coupling circuit may be considered as one time constant, and a resistor shunted by an inductance may also be considered one time constant. The output transformer may be considered as one time constant at low frequencies. At very high frequencies a resistor shunted by a capacitance is one time constant. At very high frequencies the output transformer is a much more complex device and if the speaker-system impedance increases so that the transformer may be considered to be operating unloaded it may be considered to be roughly the equivalent of two time constants.

Each time constant represents a phase shift which may reach a maximum of 90 deg. Figure 2 shows the circle diagram representing the action of one time constant. When the phase shift is 90 deg. the output voltage is zero so a feedback loop containing two time constants is stable because the gain approaches zero when the total phase shift approaches 180 deg. Figure 3 shows the results of having a larger number of time constants within the feedback loop. If we have three equal time constants within the loop the voltage gain around the loop will be reduced by a factor of 8, or 18 db, when the phase shift is 180 deg. In this case we could have about 12 db of inverse feedback and a safety margin of 6 db to allow for changes of gain due to aging of components and replacement of tubes. With four equal time constants the loss in voltage gain at 180 deg. phase shift is 4, or 12 db. This allows 6 db of feedback and 6 db for a safety factor. Since we may have as many as five time constants in an amplifier we must look for some solutions to the phase shift-gain problem if we are to apply the 20 db of feedback that we mentioned earlier.

Remedies

What remedies are available to reconcile the conflicting requirements of distortion reduction and of maintaining stability? The first and easiest method which we can adopt is to stagger the

(Continued on page 65)

AUDIO AMPLIFIERS

(from page 21)

values of the time constants of the various stages. Thus in the case of a three-time-constant circuit if we design so that one of the time constants is approaching 90 deg. when the other two are just past 45 deg., let us say one circuit at 80 deg. and two at 50 deg., we will have system which will allow the application of 20 db of feedback with almost 10 db of safety margin.

Since the Williamson type amplifier is a very popular type, let us study it in detail. An analysis of the circuit in Fig. 4 shows that it has three time constants at low frequencies—two RC coupling circuits and the output transformer; therefore we should be able to maintain low frequency stability with 20 db of feedback.

Because it is much easier to obtain response at low frequencies by the use of RC circuits than by means of transformers it is evident that we should have the longer time constants in the RC coupled stages. We should try to approach a 10-to-1 ratio between the time constant of at least one of the RC stages and the transformer primary inductance-plate to plate load combination. Such a long RC constant is difficult to obtain in the output stage of the Williamson since the output tubes are operated at a high plate dissipation which requires that the grid leak resistors be kept low in value to prevent the tubes from running away from the effects of ion currents or grid emission. The size of the coupling capacitors is similarly limited by the considerations of leakage and physical size. The time constant in the output grids is made about 1/40 sec. and the constant of the driver grid circuit is made about 1/8 sec. Exact calculations on the low-frequency characteristics of the amplifier are complicated by the fact that the primary inductance of the output transformer may change appreciably with a change of signal level; therefore, the time constant of the transformer will change with signal level.

At very high frequencies the problem of insuring stability is much more complicated because we have five time constants to deal with, two of which are tied to the characteristics of the output transformer. Even if it were easily possible there would be no advantage of making all the other time constants shorter than those of the transformer, since it is possible that the transformer alone could give 180 deg. phase shift before the gain around the feedback loop was reduced to one. It is therefore

The

WEATHERS Decorator

for Realism, Beauty, Compactness

- An integrated acoustical system with full range natural reproduction of sound.
- Engineered to produce extraordinary presence, clean dynamics and transients, voice reproduction with startling realism.
- Cabinets finished by master craftsmen.

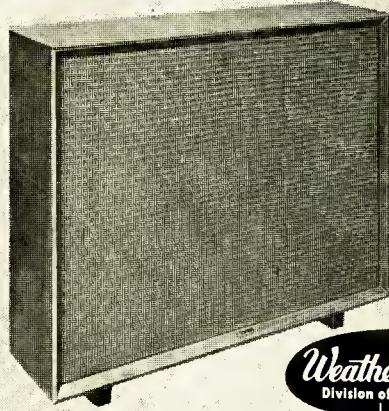

- All done by the same technical magic which produced the world's finest phonograph pickup . . . the famous WEATHERS FM 1-gram pickup.

Ideal for limited space: Weight 42 lbs., only 8 3/4" deep, 32" long, and 26" high.

Audiophile Net: Natural Mahogany \$135.00, Blonde \$139.50.

Write for full information.



66 E. Gloucester Pike,
Barrington, New Jersey

Export: Joseph Plasencia, Inc., 401 Broadway, New York 13, N. Y.

COMING to your city HIGH FIDELITY MUSIC SHOWS

See and hear the latest in HIGH FIDELITY from leading high fidelity manufacturers . . .

Don't miss these public showings of Hi-Fi Equipment . . . from the most economical units for the budget-minded to spectacular home music theatres . . . compare and enjoy them all. Components and complete systems will be displayed.

THREE DAYS OF CONTINUOUS DEMONSTRATIONS

1 P.M. to 10 P.M.

Minneapolis-St. Paul	January 11, 12, 13	Dyckmann Hotel
Detroit	February 1, 2, 3	Statler Hotel
Cleveland	February 22, 23, 24	Hollenden Hotel
Pittsburgh	March 8, 9, 10	Penn-Sheraton Hotel
Baltimore	March 22, 23, 24	To be announced
Seattle	August 23, 24, 25	To be announced
Portland, Ore.	September 6, 7, 8	To be announced
Cincinnati	September 20, 21, 22	Sheraton-Gibson Hotel
Miami	October 18, 19, 20	McAllister Hotel
St. Louis	November 22, 23, 24	Statler Hotel

Rigo Enterprises, Inc. 500 North Dearborn Street, Chicago 10, Illinois

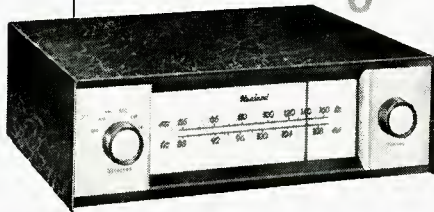

"Golden Series" HI-FI



The "GOLDEN GATE" AM-FM Tuner...with an FM sensitivity of 3 microvolts for 20 db of quieting—and a host of other remarkable features...

one of a complete line of advanced design high fidelity tuners, amplifiers and components...

hear these quality RAULAND units at your Hi-Fi dealer or write for details...

RAULAND-BORG CORPORATION
3515 W. Addison St., Dept. G, Chicago 18, Ill.

Circle 66A

If you're interested in true high fidelity YOU NEED THIS!

... The authoritative, easy-to-understand story of how a hi-fi loudspeaker works. Tells you how to judge a good loudspeaker...

... what to look for, listen for. 32 fascinating pages, including dozens of diagrams and delightful cartoons. *Only book like it!* A wonderful guide for everyone who has a hi-fi system. A *must* for everyone who plans to purchase one!

Yours FREE—just send a dime to cover cost of mailing.

University Loudspeakers, Inc., White Plains, N. Y.



UNIVERSITY LOUDSPEAKERS, INC. Desk R-11
80 South Kensico Ave., White Plains, N. Y.

Gentlemen: Please send me my copy of "Speaking about Loudspeakers." Enclosed is Dime to cover the cost of mailing.

NAME _____

ADDRESS _____

CITY _____ STATE _____

Circle 66B

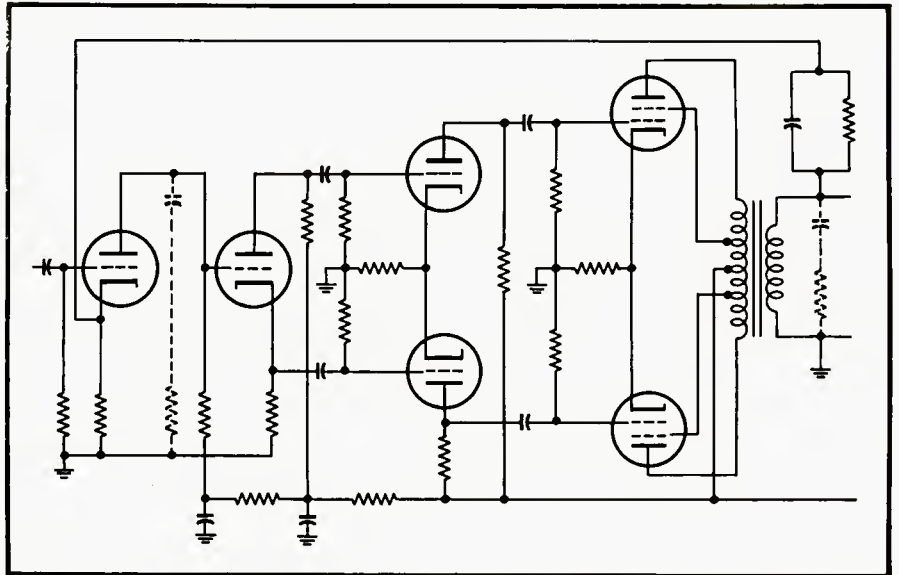

Fig. 4. Simplified schematic of a Williamson-type amplifier. Network shown dotted in plate circuit of first tube will change amplitude and phase response.

necessary to design the other stages so that the response of the whole circuit is down considerably before the resonant frequency of the transformer is reached. It is for this reason that it is necessary to have a transformer with good high-frequency response in order to obtain satisfactory operation in a feedback amplifier.

Although feedback will compensate for a great deal of loss within the band pass of an amplifier, an examination of the basic feedback gain equation will show that such a loss comes off the top of the amplification. That is, when the "raw" gain of the amplifier is reduced the over-all gain remains almost constant and the gain reduction due to feedback and with it the distortion reduction are diminished almost as much as the raw gain. For this reason the benefits of the feedback will be lost to about the same extent that the raw gain is lost. With such a limitation it is desirable to make

two of the RC time constants somewhat longer than those of the transformer and give special treatment to the other one. A step circuit connected from the plate of the input amplifier to ground, shown dotted in Fig. 4, can be added. Such a network will cause the first stage to have an amplitude and phase response as shown in Fig. 5. This response coupled with the response of the other two resistance-coupled stages can give a system that is just barely stable. A little margin of safety can be realized by making B a complex quantity with phase characteristics the opposite of those of A. This may be done by shunting all or part of the feedback resistor with a capacitor. In Fig. 4 all of the resistor is shown shunted.

Testing Procedures

Since very few individual experiment-

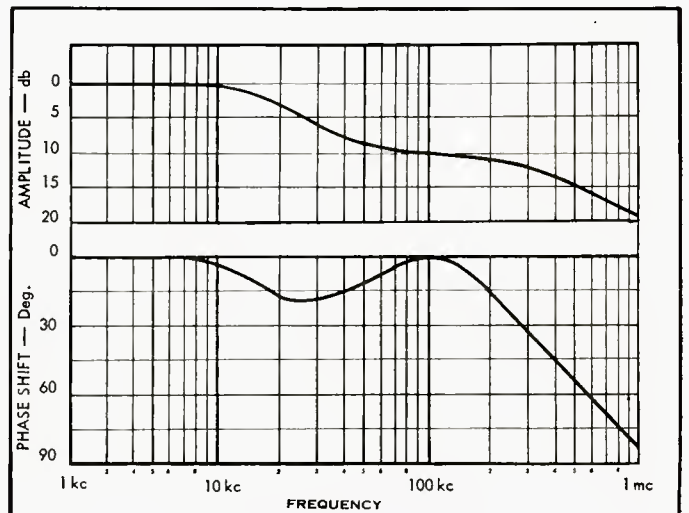

Fig. 5. Effect of network of Fig. 4 on amplitude and phase response.

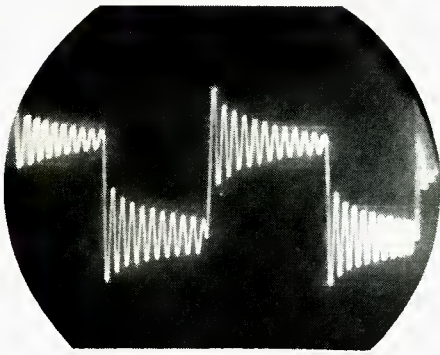

Fig. 6. 'Scope pattern showing ringing on 10,000-cps square wave.

ers or hobbyists who build audio amplifiers have phase meters or access to them and very few have audio oscillators with a range of 1 to 100,000 cps, the preceding information is of interest mainly for background purposes. With the minimum equipment which one should have available in order to adjust high-fidelity

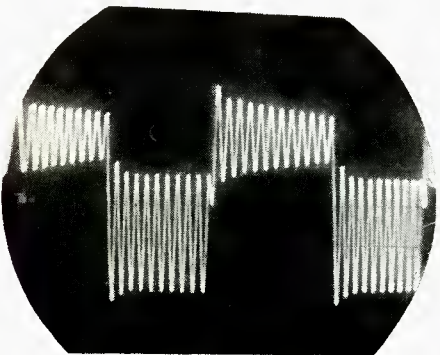

Fig. 7. When small capacitor is added across output circuit, oscillation increases.

systems the practical aspects of the stability problem can be worked out. This minimum of equipment consists of an audio oscillator which produces sine and square waves at frequencies up to 10,000 cps and an oscilloscope which will display these waveforms. Most oscilloscopes have response up to 100,000 cps and are thus adequate to reproduce a 10,000 cps square wave. An oscilloscope with a slow sweep speed of about two seconds is very useful for the investigation of the low-frequency response of the amplifier to transients, but essentially the same information can be obtained by watching a meter needle or a speaker cone when transients are fed into the amplifier. If only a sine wave oscillator is available a simple clipper can be built to change the sine waves to square waves.

Once an amplifier is finished it should be turned on with a resistance load connected to the terminals and the feedback loop disconnected. An oscilloscope should

be connected across the load and the audio oscillator connected to the input of the amplifier. The oscillator should be adjusted to furnish a small signal and the oscilloscope should be set up so that a trace of a convenient size is visible on the screen. Next the feedback network should be connected. If the amplitude of the trace on the 'scope screen is reduced you have everything hooked up correctly. If the amplifier goes into violent oscillation at some medium frequency it is necessary to reverse either the primary or the secondary leads of the output transformer. If instead of achieving a reduction of height of the trace when the transformer connections are correct you get very high frequency oscillations you have an amplifier which is unstable with the amount of feedback used and the amount of feedback should be reduced until steps are taken to increase the stability of the amplifier.

It may also happen that the amplifier is unstable at low frequencies which will be evidenced by motorboating which may either be spontaneous or be dependent upon being initiated by some transient. In this case also the amount of feedback should be decreased until the amplifier is stable so that means of increasing the margin of stability can be explored.

Taking the high-frequency troubles first; after stability has been restored by decreasing feedback a 10,000-cps square wave should be applied to the input of the amplifier. The wave form shown on the oscilloscope will be likely to have the appearance of Fig. 6 which shows violent ringing on the top of the 10,000-cps square waves. A .005 μ f capacitor connected across the load resistor gives the waveform shown in Fig. 7. The capacitor lowers the resonant frequency of the output and thereby reduces the stability of the amplifier. Figure 7 shows that the amplifier is almost in continuous oscillation. When the step circuit

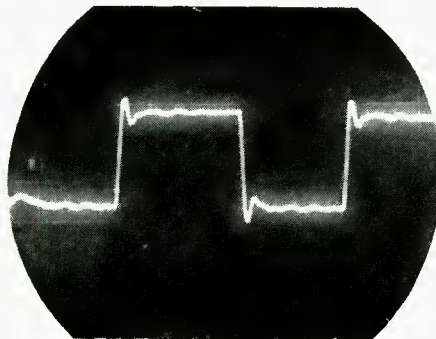
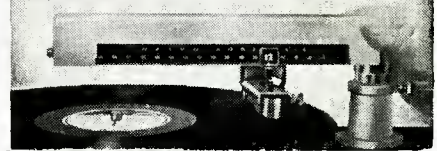

Fig. 8. Addition of network of Fig. 4 reduces ringing appreciably.

**NOW ULTIMATE PERFECTION
IN TONE ARM PERFORMANCE**

Ortho-sonic V/4

TRACKS COURSE OF ORIGINAL RECORDING STYLUS



Vital Facts About TONE ARMS

In his new book, HI-FI GUIDE,* Donald Carl Hoefler, internationally famous authority on sound engineering, says this about the ORTHO-SONIC V/4 tone arms:

"One of the newest and most revolutionary, on the other hand, is the Orthosonic V/4. This is the commercial realization of an idea which is as old as recording itself.

"Engineers have been attempting unsuccessfully for many years to perfect an arm which will move the reproducing stylus in a straight line across the record, this being the path followed by the original cutting stylus. When the playback does not occur along this path there is said to be tracking error . . .

"The design problems here are obvious. In addition to straight-line movement, it is essential that this movement be virtually frictionless. And it was this latter requirement that most designers have had to admit defeat. Now, however, the developers of the Orthosonic claim to have licked the problem, and the preliminary evidence would indicate that the claims are well founded. If so, they have absolutely nothing to worry about. If it lives up to its promise, the Orthosonic arm will make pivoted tone arms as dead as the dodo bird."

Ortho-Sonic V/4 solves the problem; it permits the stylus to ride the center of the groove; makes old records sound like new; preserves record life and stylus wear!

MODEL #100 (12" size) \$35.95
MODEL #200 (Transcription) \$44.50
MODEL #300 (Binaural) \$59.50

Leading hi-fi dealers everywhere now demonstrate the ORTHO-SONIC V/4. Ask for it, or write to us for descriptive literature.

REDDI-SWEEP

Indispensable Hi-Fi Record Brush

SAVES RECORD and STYLUS LIFE

Complete \$4.95



* MECHANICS ILLUSTRATED, Hi-Fi Guide, Published by Fawcett Publications, Inc.

ORTHO-SONIC INSTRUMENTS, Inc.
66 B Mechanic Street, New Rochelle, N. Y.

pfK
pre-finished
Kits

PFK-120/150

PFK-500

PFK-300

designed by
Paul Klipsch

Now you need only a screw-driver to put together a furniture-finished Klipsch speaker enclosure, indistinguishable from factory-assembled Rebel 3, 4 or 5. Also available as conventional, unfinished kits.

Write for Complete Catalog!
36 pages . . . 16 other hi-fi kits . . . 29
equipment cabinets . . . 4 matched speaker
systems . . . 20 hi-fi accessories.

cabinart '57

Cabinart

99 North 11th Street
Brooklyn 11, N. Y.

largest manufacturer of cabinets and kits for hi-fi
a division of G&H Wood Products Co., Inc.

Circle 68A

**ON EVERY SALES TRIP
I DICTATE RIGHT
FROM
MY CAR**

On your next business trip, take your dictating machine with you in your car. Confirm your interviews, make sales reports, handle correspondence en route, with your wire or tape recorder beside you on the drivers seat. Recordings are easily mailed back to the home office or elsewhere for transcribing. Your mail goes out while you go on. Recorder operates right from your 6 or 12 volt auto battery with a CARTER CONVERTER that supplies the required 110 v. AC.

ASK YOUR RADIO PARTS DISTRIBUTOR about CARTER CONVERTERS or Mail Coupon for illustrated circular and full details.

CARTER MOTOR CO.

MAIL THIS NOW

Carter Motor Co.
2748 W. George St.
Chicago 18, Illinois

Please send illustrated circular and full information on Carter Converters.

Name _____

Address _____

City _____ State _____

Circle 68B

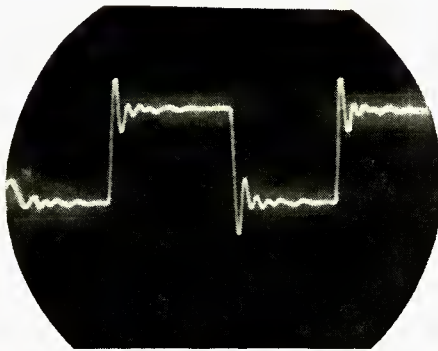

Fig. 9. Capacitor across output emphasizes overshoot of amplifier, even with Fig. 4 network in place.

of 4700 ohms and .001 μ f is connected from the plate of the first tube to ground the waveform of Fig. 8 is produced. There is a slight overshoot on the leading edge of the wave. This overshoot is emphasized when a .05- μ f capacitor is

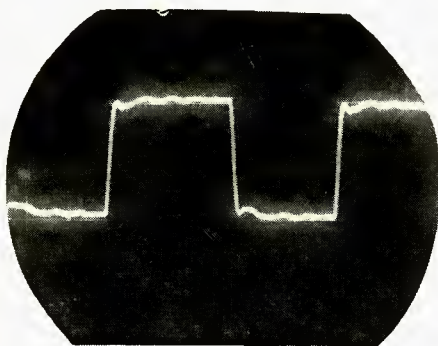

Fig. 10. Adding small capacitor across feedback resistor of amplifier changes pattern of Fig. 9 to this.

put across the load as shown in Fig. 9. A 150- μ f capacitor across the feedback resistor removes the overshoot as shown in Fig. 10. Capacitors up to .05 μ f make no appreciable difference when connected across the load.

The component values listed above may not be exactly correct in all cases, but they give a starting point and with most Williamson-type amplifiers with quality transformers the correct values will probably not be too much different from the ones listed. If the steps listed above do not cure your difficulties a 47-ohm resistor and 0.1- μ f capacitor in series should be connected across the output terminals. This combination serves to load the transformer secondary at very high frequencies thus reducing the phase shift introduced by the trans-

former.

As the stability of the amplifier is increased the feedback may be increased until the desired amount has been reached. The margin of safety remaining may be estimated by connecting capacitors in the order of .002 to .02 μ f across the output terminals of the amplifier. If a capacitance of .005 μ f or greater across the terminals does not cause the amplifier to go into oscillation at some high frequency, the high-frequency stability is probably satisfactory.

It may be that, in the process of achieving high-frequency stability and increasing the feedback, low-frequency instability has appeared. Because most amplifiers have less potential phase shift and also because inferior transformers actually decrease the problem of attaining and maintaining low-frequency stability the low-frequency problem is not likely to be so acute. Generally the increase of coupling capacitors and grid leaks to the maximum desirable values will take care of the problems.

Figure 11 shows the effect of a transient upon an amplifier which is marginally stable. After more than a second the oscillations started by the transient have not nearly damped out. Figure 12 shows the improvement of low-frequency stability which was accomplished by increasing the time constant of the driver circuit grids and decreasing the time constant of the input circuit which is outside the feedback loop. Figures 13 and 14 show the improvement in overload recovery which were accomplished by the same changes. Once a stage within the feedback loop is driven beyond its dynamic range the feedback is no longer effective because there is little if any incremental amplification present. That is to say that additional input gives little or no additional output; therefore, if there is no gain there can be no gain reduction and consequently no distortion reduction. It is most desir-

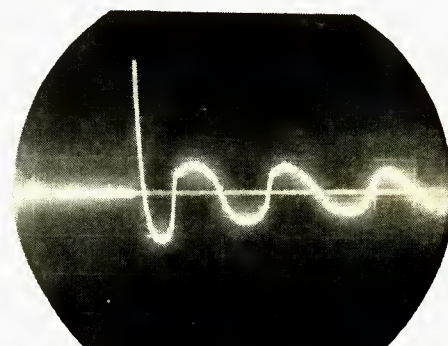

Fig. 11. Effect of transient on an amplifier which is marginally stable.

able to prevent signals which will drive the amplifier beyond its dynamic range from reaching the amplifier input terminals. Despite much talk to the contrary there is little likelihood that the program material played through a high-fidelity system will include such signals since the program material has already been limited in amplitude and frequency range by the previous systems through which it has been processed. Both disc and tape recording systems have such limitations and, although a frequency modulation transmitter may have excellent transient and frequency response, it is likely that most of the program material will have been through some line or program amplifiers which have a response characteristic which is not better than that of the home equipment.

Speaker Distortion

It is possible that some of the program material will be beyond the capabilities of the speaker system to handle. It is most desirable to eliminate these signals before they reach the speaker since a speaker driven beyond its linear limits is a copious source of intermodulation. The limitation of the low-frequency response of a system can best be accomplished by installing a high-pass filter between the tone control amplifier and the output amplifier. This filter should cut off at a frequency no lower than 20 cps and preferably higher if the speaker system does not have an exceptional low-frequency response. Such a filter not only prevents program material which the speaker cannot handle from reaching the speaker, but it also prevents transients which may result from switching or from interference from overloading the amplifier. It also increases low-frequency stability in cases where the tone-control amplifier gets its plate power from the output amplifier.

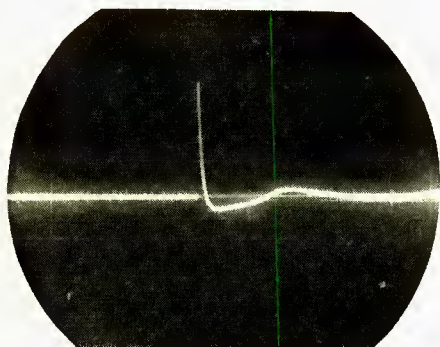

Fig. 12. Improvement over pattern of Fig. 11 is caused by changing time constant of driver grid circuit.

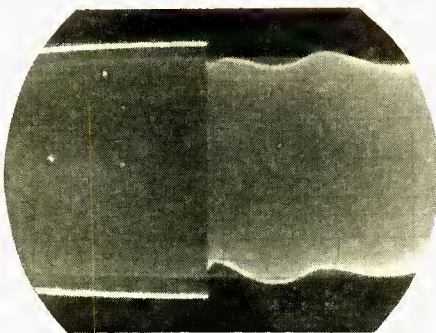

Fig. 13. Overload recovery of amplifier in condition shown in Fig. 11.

As a final check of stability the amplifier should be operated with each of the output tubes removed alternately to see if oscillation ensues. While one of the tubes is removed the amplifier should be driven to saturation at some

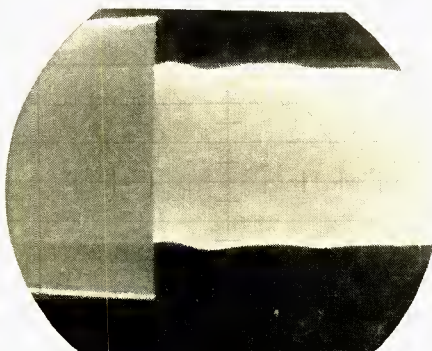
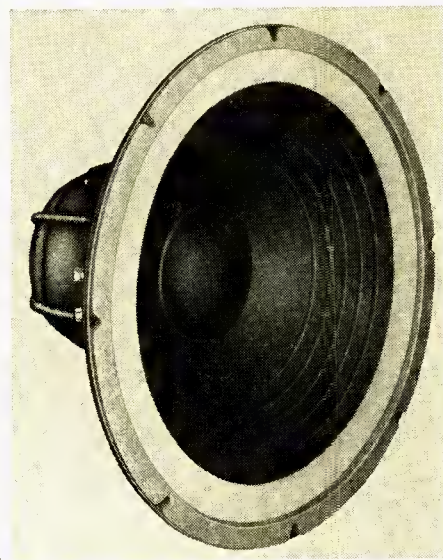

Fig. 14. Overload recovery is improved when changes are made as indicated in Fig. 12.

low frequency to see whether or not little bursts of high-frequency oscillation occur at some time during the low frequency cycle. As an acid test on my own amplifiers I repeat this test with the load removed, however anyone who does this should bear in mind that he is risking the output transformer should some high-amplitude oscillation result.

Although there are simpler amplifiers which will produce sufficient high-fidelity audio power to fill a living room, the Williamson amplifier or the circuits derived from it will give results which cannot easily be excelled. If your Williamson sounds bad it might be a good idea to check on its stability because there must be a great many of them in the condition of the amplifiers from which I made the "before" oscillograms. With just a little work they can be made as good as the amplifiers from which the "after" oscillograms were taken.

NOW HEAR THIS!



P. O. Box 21
Pearl Beach, Mich.
August 15, 1956

Racon Electric Co., Inc.
1261 Broadway
New York, N. Y.

Gentlemen:

Immediately upon arrival of the Racon 15-HW woofer speaker, I mounted it in my sand-filled reflex enclosure which I just completed. I am using the 15-HW with an 800 cps X-over, in conjunction with a Lorenz 8" midrange and a Lorenz 2½" H.F. cone speaker, X-over at 5000 cps, and which are mounted on a separate small baffle on top of the L. F. enclosure.

As a test recording for my new system, I purposely secured a Richard Purvis Organ recital, 7½ ips tape which I found to be very outstanding. I am happy to say the reproduction is superb. The lowest organ notes are clearly defined, without the lightest sign of distortion or overhang. I have listened to scores of manufactured speaker systems and have yet to hear one which would satisfy me like the one I now have, regardless of price.

I will certainly recommend your speaker, whenever the occasion arises.

Yours truly,
O. W. Schneider



If your loudspeaker system is suffering from inadequate low frequency response, spend a few minutes listening to the RACON Model 15-HW at your nearest sound distributor. Don't forget to ask him about the unique "HI-C" cone suspension (pat. pending) which provides high compliance, inherent damping and a resonant frequency of 24 cycles. **Audio-ophile net, \$69.50.**

P.S. RACON, like LORENZ, also manufactures a quality line of mid-range and high frequency speakers.

Write for free literature



Export: Joseph Plasencia
401 Broadway, New York, N. Y.

Canada: Dominion Sound Equipments Ltd.
4040 St. Catherine St., West—Montreal 6, Que.