

# A 60-WATT "ULTRA-LINEAR" AMPLIFIER

By  
**DAVID HAFLER**  
Acro Products Company

**M**ANY high fidelity amplifier circuits have been made available in the low and medium power brackets. However, there has been very little activity in development and public dissemination of high powered amplifier circuits in the power range over 50 watts.

There are many applications in which high powered, high fidelity amplifier capabilities are desirable or even mandatory. In addition to non-sound reproducing functions in laboratory and industrial applications, high powered audio units find application in recording work, in auditorium and amphitheater work, and in systems where power is divided over many different speakers in different rooms or areas. There is also a school of thought which believes that high power is required in home high fidelity installations for the ultimate in realistic reproduction.

The necessity for high power in home use has been doubted by some authorities, but its proponents have several valid arguments which must be given some weight. They claim that high power is required for proper reproduction of musical transients since transient waveforms require more power than the sine waves which are used as the basis for conventional amplifier ratings. For example, reproduction of a square wave of given amplitude requires *twice* the power of a sine wave of the same amplitude.

Another cogent argument for high power is that amplifiers have to work into loudspeaker loads of widely varying impedance. At the bass resonant frequency a loudspeaker might show an impedance of many times the nominal value. No amplifier can deliver its rated undistorted power into a load which represents such a severe mismatch. A wide reserve of power capability is thus required to maintain high fidelity operation under normal listening conditions. The argument, which always is used as a "clincher" for high power, claims that like a high powered car, a high powered amplifier is smoother at all levels because

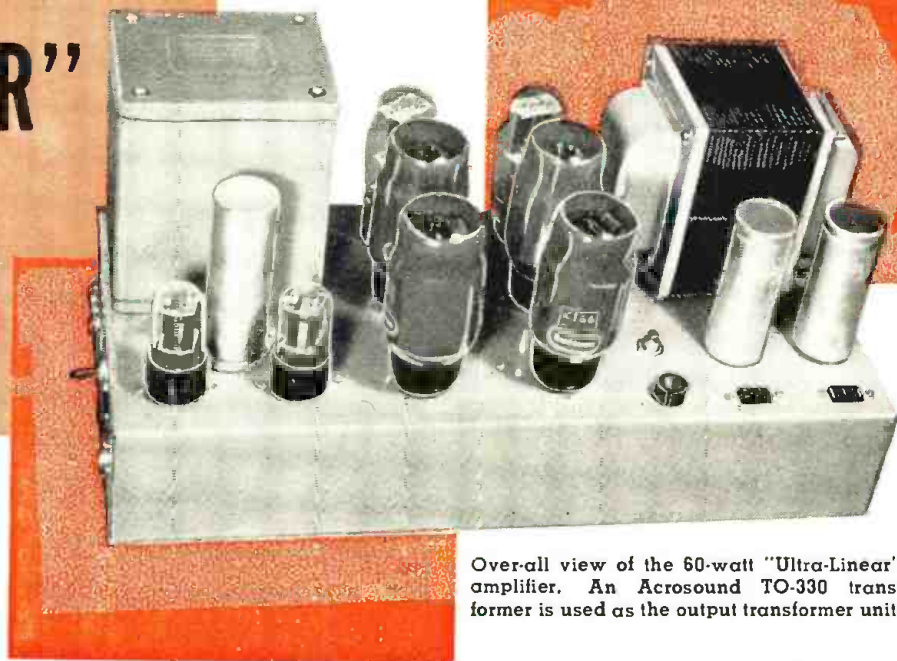

Over-all view of the 60-watt "Ultra-Linear" amplifier. An Acrosound TO-330 transformer is used as the output transformer unit.

*Construction details on a commercially-designed, high-power amplifier for the serious audiophile. It uses four KT66's.*

it operates at only a fraction of its potentialities and is rarely pushed to the limit.

On the other hand, many experiments have been made to demonstrate that only a few watts are needed in home installations. This is generally done by measuring the *average* power used in a specific installation and allowing for an estimated ratio of peak to average power. This type of test indicates the *customary* listening level at a specific audio installation. It does not actually indicate how much power would be required to simulate the *realistic* auditory loudness of live music. Few people are interested in reproducing the full acoustic power of an orchestra in their living rooms. However, many want to have the same sound pressure at their ears that they would get in the concert hall. Anybody who has listened to a full scale symphonic orchestra, or even a large dance band, is immediately aware that it takes tremendous power to duplicate the same sound intensity even in a smaller room where power requirements are far below those of the concert hall.

If the goal of high fidelity is "concert hall realism in the home" as many people agree, then a lot of power is required. Estimates of requirements run extremely high. One published figure<sup>1</sup> calls for 100 watts of clean power. In contrast, estimates based on average usage generally run about 10 watts. Superficially, this divergence of opinion looks extreme. However, the range of 10 to 100 watts is only 10 decibels wide

—approximately 10 audible steps of difference. The extremes are not as far apart as it appears on the surface, and it is probable that an intermediate rating will serve the needs of the most critical home installations. However, it is difficult to achieve intermediate power levels of 50 watts or more using conventional parts and conventional circuitry.

## Approaches to High Power

There are many designs available for powers up to about 25 watts. When this point is passed, ordinary operating conditions and circuits are not directly applicable. When it is desired to exceed 50 watts of clean power and still preserve high quality, the problems of design are rather acute. There are several possible approaches which warrant consideration:

1. *Class B* (overbiased operation) provides high efficiency and delivers high power at low operating cost. However, overbiased operation causes excessive distortion at lower levels even though high level distortion can be made relatively low. A Class B amplifier with 1 per-cent distortion at 50 watts may have ½ per-cent at 1 watt—an excessive amount for high fidelity standards. Class B amplifiers also have inherently poor regulation, and careful attention must be paid to the design of power and bias voltage supplies or peaks of operation will shift voltages and operating conditions causing transient distortion.

2. *Class AB<sub>2</sub>* operation provides high power by driving the output stage into

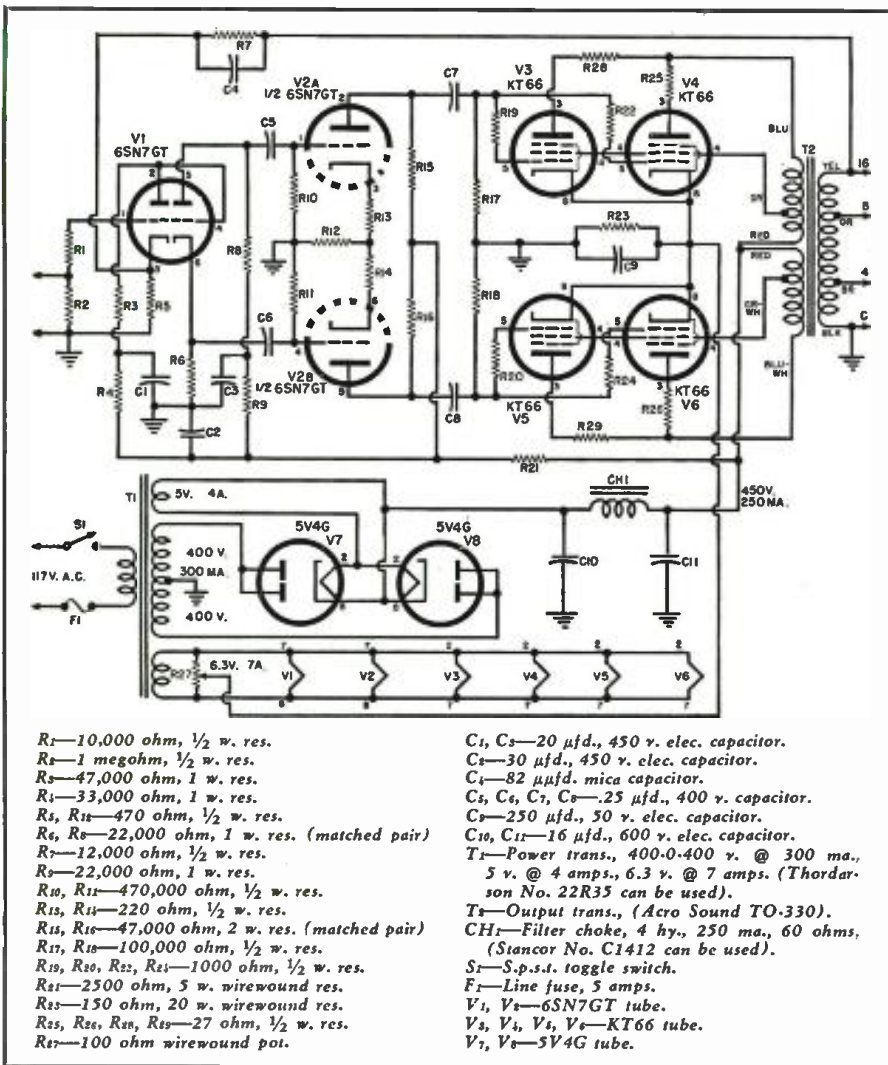

Complete schematic diagram of the Acro-designed 60-watt "Ultra-Linear" amplifier.

the grid current region. The driving stage must be able to deliver power at low distortion into the output grids. These grids present a low impedance when they are driven positive, and distortion is created in the driving stage unless transformer coupling or other involved and expensive circuitry is utilized. This mode of operation also has poor inherent regulation as the Class B stage with consequent problems of power supply design. Lastly, it utilizes a lowered plate to plate impedance to get higher output, and this creates high distortion at low levels similar to what happens with a Class B stage.

3. *High voltage transmitting tubes* can be used for high power output. However, the associated voltages are in the lethal range of 1000 volts or over, which is definitely undesirable. In addition, the tubes and necessary power supply make the amplifier quite costly.

4. *There are "hot" tubes* on the market such as the RCA 6146 (and the Tung-Sol 6550 which will be available shortly) which can provide high power at reasonable supply voltages. Experiments with these tubes for high fidelity circuits are being carried out, and results will be made available

eventually. Present efforts have not surmounted all the problems of using these tubes in reasonably-priced, efficient circuitry.

5. *Parallel operation* of tubes is relatively inefficient and requires careful design to avoid parasitic oscillations. However, there can hardly be a better way of getting high power than by taking a stage of desirable characteristics and paralleling it with another stage. Williamson mentions using sufficient pairs of output tubes in his famous circuit to achieve 70 watts of output. The inefficiency of this arrangement renders it rather impractical; but if the basic stage is efficient and can do better than 25 watts, parallel operation with two pairs of tubes will produce the desired output power and will still be practical.

#### Circuit Considerations

Consideration of the various alternatives for getting high power and high fidelity simultaneously points to the paralleled stage as being the simplest and most foolproof and bug free. It is not efficient, but this means merely that a slightly higher drain is put on the electric meter than would exist with Class B or Class AB<sub>2</sub> operation.

Efficiency is of minor importance unless portable operation is required where power is costly.

The choice of type of output stage to parallel is restricted. There are no triode stages with conventional receiving tubes which provide sufficient output. Tetrode stages have excessive low level distortion, are very sensitive to impedance mismatch and, therefore, are subject to nonlinearity using speaker loads since these have a reactive component and an impedance which varies with frequency. The choices left are the Ultra-Linear stage or the tetrode with local feedback such as is achieved with a cathode winding on the output transformer. This latter circuit has had a recent revival of popularity after favorable comment by Williamson.

Obviously, the use of local feedback will improve the characteristics of the output stage and seems to be an attractive arrangement. However, there is a penalty attached to the use of feedback. Sensitivity is reduced in proportion to the amount of feedback. This puts a severe limitation on the use of feedback over an output stage alone. In the circuitry under consideration, the driver stage must supply about 30 volts r.m.s. to each output grid. If 6 db of local feedback is used on the output stage, the driving requirement is 60 volts r.m.s., or about 88 volts peak, for each grid. This brings the driver stage to the point where its distortion becomes significant.

Good design calls for integrated performance of an amplifier, and the driver and output stage must be considered as a unit. On this basis, a conventional type of RC coupled driver combined with an Ultra-Linear output stage will give less distortion than the same driver and a tetrode stage with cathode feedback. Therefore, Ultra-Linear operation has been selected for the paralleled output stage. The justification of this choice is shown by the extremely low distortion characteristics of the push-pull parallel amplifier.

Experience with paralleled output tubes has indicated that some parasitic oscillation is probable unless "stoppers" are used for partial isolation of paralleled elements. The present design, therefore, uses grid stoppers of 1000 ohms each and plate stoppers of 27 ohms each. These eliminate the usual difficulties encountered when tubes are paralleled.

The four tube output stage requires the same signal drive at the grids as is needed in a two tube circuit. Therefore, a push-pull driver stage similar to that of the Williamson circuit will handle the drive requirements adequately and with low distortion. This, in turn, can be preceded by any high quality phase inverter. Again the Williamson arrangement of voltage amplifier directly coupled to the cathodyne inverter is satisfactory.

The basic tube alignment described must be powered by a fairly heavy



power supply. The use of four output tubes doubles the normal current consumption of the Ultra-Linear output stage, and the B+ requirement is about 250 ma. To exceed 50 watts of clean output, the B+ voltage should be in excess of 425 volts. A 300 ma. transformer of 400 volt rating, along with two 5V4G's paralleled, and capacitor input can supply the amplifier with the desired requirements. There is no need for choke input or other means of improving power supply regulation because the amplifier has good inherent regulation with practically no change in current drain as the output level is varied. This good regulation is a very desirable characteristic of the amplifier as it obviates the possibility of transient distortion caused by momentary changes in tube operating conditions. It makes the use of cathode bias practical, just as with Class A triode stages, since the constancy of cathode current in the output tubes maintains a corresponding constancy of bias, with a fixed drop across the cathode resistor.

The final element in the design of the amplifier, and a very important element, is the feedback circuit. In a circuit of the quality sought, it is desirable to utilize about 20 db of negative feedback in order to provide the well known advantages of lowered distortion, reduced hum and noise, and improved damping of the loudspeaker. However, feedback must be integrated into the design and cannot be added haphazardly or indiscriminately with the expectation of experiencing no difficulty. It is probable that the uninformed use of feedback will result in the degraded performance of most circuits since the feedback may not be stable, and *regeneration* rather than *degeneration* will be experienced. This can cause increased distortion, hang-over, boom, and screechy effects caused by high frequency ringing. Even if the amplifier is stable under quiescent conditions, it is possible for instability to occur momentarily under some operating conditions. This transient instability is one of the factors which makes for discrepancy between the measured performance of an amplifier and its listening characteristics. They can measure well and not sound well.

#### Considerations of Feedback Stability

In any feedback amplifier, regeneration will occur if the phase shift reaches 180 degrees before the amplifier gain has dropped by an amount equal to the amount of feedback. For example, if it is desired to use 20 db of feedback, the 180 degree phase shift points at high and low frequencies should not be reached until the gain of the amplifier without feedback has decreased by at least 20 db. In other words, phase shift must be kept down until the normal roll-off of the stages has taken effect.

A quick appreciation of the design problems involved can be had by observing the problems of feedback de-

AMPLIFIER SPECIFICATIONS	
POWER RATING .....	60 watts at not over 1 per-cent IM distortion
SENSITIVITY .....	1.3 volts r.m.s. for 60 watts output
FREQUENCY RESPONSE .....	@ 1 watt plus or minus 1 db; 2 cps to 200 kc. @ 20 watts plus or minus 1 db; 10 cps to 100 kc. @ 60 watts plus or minus 1 db; 20 cps to 20 kc.
DAMPING FACTOR .....	16

sign at low frequencies. If there are two RC stages and the output transformer included in the feedback loop (as is true in the Williamson type of circuit), there are three sources of low frequency phase shift. If each of these has the same time constant, the 180 degree point is reached when each of these three sources contributes 60 degrees of phase shift. In this hypothetical case, the gain has decreased 18 db at the critical phase shift point, since 60 degrees of phase shift corresponds to 6 db of gain reduction in a single stage, and there are three such stages involved. Thus 18 db is the limit to the permissible feedback if instability is to be avoided.

How can 20 db of feedback be run if the amplifier goes unstable with 18 db? The answer is that the phase shift must be reduced. This can be accomplished by introducing *phase shifting networks* or by *staggering* the time constants of the various stages so that a given gain reduction is accompanied by less phase shift.

The low frequency stability of the original Williamson circuit was dependent on two RC networks with equal time constants and the output transformer time constant. When the inductance of the transformer made its time constant equal to that of the interstage networks, 20 db of feedback could not be accomplished with the desired degree of stability. Since the transformer's time constant is variable depending on the d.c. balance of the output tubes, a.c. excitation level of the output stage, variability in core material, production quality control, etc., there was always the possibility of running into instability either continuously or during some intervals of

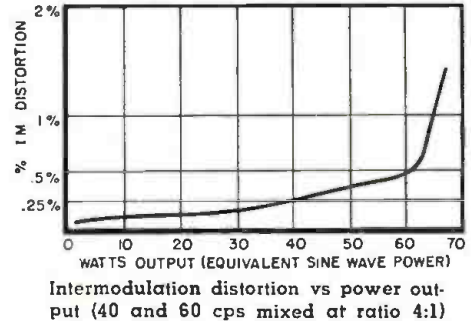

use. This is certainly an undesirable condition which caused many Williamson amplifiers to have low frequency instability.

When the Ultra-Linear version of the Williamson type circuit was designed, this problem of low frequency stability was investigated, and steps were taken to extend the margin of stability. This was done by *staggering* the interstage RC networks by lengthening one of them. The same expedient has proven beneficial in the push-pull parallel version of this circuit and has, therefore, been included in the design.

The high frequency stability problem is not as simple to analyze because of the fact that the performance of the output transformer at high frequencies is more complex than that of a simple RC network. As a general rule, the amount of feedback obtainable at high frequencies for a given circuit is directly dependent on the quality of the output transformer which must have both low and smooth phase characteristics over a very wide bandpass. Many criticisms leveled at feedback circuits made condemnations  
(Continued on page 100)

Underchassis view of the 60-watt amplifier. Parts layout eliminates hum problems.

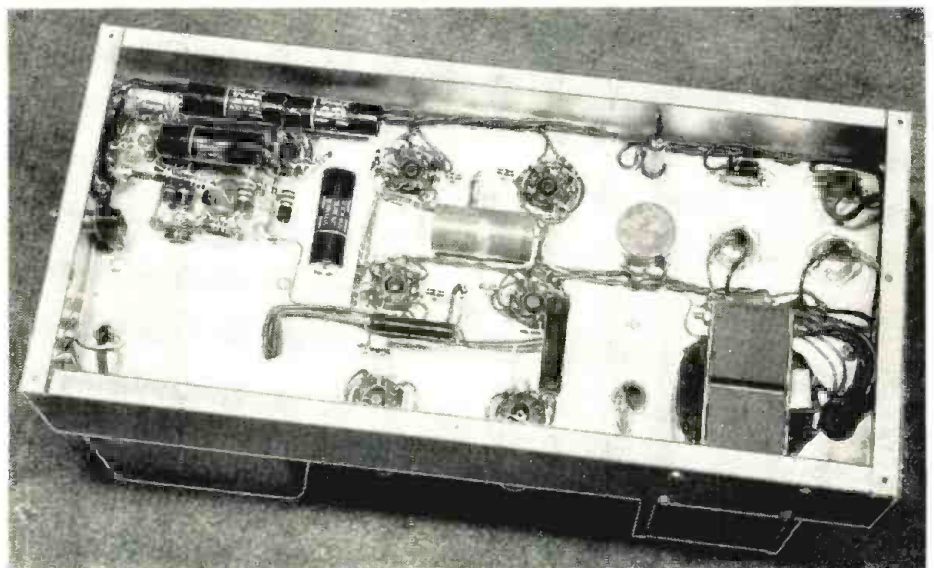



**NEW!** All Channel  
**SUPER POWERFUL VHF-UHF TV RECEPTION**  
**IN ALL DIRECTIONS**

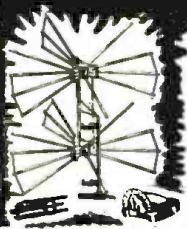

Only **\$23.50**  
Model AX-524  
**ROCKET DIRECTRONIC MOTORLESS TV ANTENNA**  
**360° ELECTRONICALLY SWITCHED BEAM**

In the fringe or ultra fringe, the NEW 1955 Motorless Directronic will outperform any ordinary antenna. This sensational new 360° UHF-VHF TV antenna provides superb ghost-free picture clarity. Model AX-524 "Serviceman's Array" contains Hi-Pac Molded Insulator of Extreme tensile strength, 24 hi-tensile aluminum elements, including 6 Multi-purpose Reflector-directors. 1 set matched tie rods. Universal Mast Clamps, 6-position Beam Selector Switch, 75' Lossless UHF-VHF Tubular TRI-X Cable.

Antenna offers "around the compass" reception WITH-OUT Rotors. Provides superb ghost-free picture clarity. Model AX-524 "Serviceman's Array" contains Hi-Pac Molded Insulator of Extreme tensile strength, 24 hi-tensile aluminum elements, including 6 Multi-purpose Reflector-directors. 1 set matched tie rods. Universal Mast Clamps, 6-position Beam Selector Switch, 75' Lossless UHF-VHF Tubular TRI-X Cable.

**Super UHF RECEPTION HI-GAIN YAGI**



Provides Guaranteed sensational UHF fringe reception. Amazing sensitivity provides up to 30 db gain, using 2, 4, or 6 bay stacked arrays. Ghosts, interference, minimized or eliminated. Each serviceman's array provides 4 directors, 2 folded dipoles, 2 reflectors. And our low price insures a low cost installation. Select the model required in your area.

**\$1.95** Ea.  
Model ..... Covering  
F-7A ..... Channels 14-48  
F-7B ..... Channels 27-62  
F-7C ..... Channels 47-83  
Matched stacking bars \$0.30 pr.

**UHF CORNER REFLECTOR**  
**ONLY 2.99 EACH IN LOTS OF 6**  
**SINGLE LOTS \$3.50 EACH**

This hi-gain UHF Corner Reflector can only be offered you at this low, low price for a short time, 8 to 11 db gain across UHF band. Order Model F-6.

ALL PRICES F.O.B. CLEVELAND, OHIO  
Do not remit more than complete purchase price. Pay shipping charges on receipt of goods. 25% deposit on all C.O.D. orders, please. Money-back guarantee.  
Prices Subject to Change Without Notice.

Our **Greatest BARGAIN**

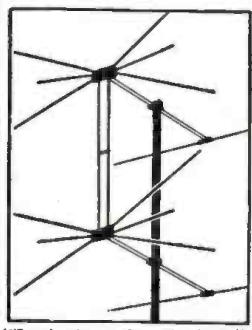

2-BAY  
**16-ELEMENT CONICAL ARRAY**  
With Hi-Band Adapters  
Sturdy 3/4" Elements

**\$4.99 EACH** IN LOTS OF THREE  
SINGLE LOTS \$5.30  
Never before has National Electronics had a BARGAIN like this. We made a special purchase in order to get these sensational prices. And this array has everything. This conical 2-bay 16-element array provides ultra-fine fringe reception. Includes sixteen 3/4 inch airplane type aluminum elements, including hi-band adapters for greater gain on the high channels and is complete with one pair of stacking bars to each array. These are packed in cartons of three 16-element arrays per carton, with tie rods, at \$14.95 per carton.  
When purchased in single 16-element arrays, separately boxed—your cost is..... \$5.30 each  
3 Two-Bay Arrays per carton without Tie Rods..... \$13.50 carton  
4 Bay Ultra-Fringe Stacking Assembly for Above—Model 48..... \$1.95 set

type aluminum elements, including hi-band adapters for greater gain on the high channels and is complete with one pair of stacking bars to each array. These are packed in cartons of three 16-element arrays per carton, with tie rods, at \$14.95 per carton.  
When purchased in single 16-element arrays, separately boxed—your cost is..... \$5.30 each  
3 Two-Bay Arrays per carton without Tie Rods..... \$13.50 carton  
4 Bay Ultra-Fringe Stacking Assembly for Above—Model 48..... \$1.95 set

**FAMOUS ROCKET ZOOM-UP TOWERS**

Sturdy • Reliable • Easiest Installation  
Economize with Rocket Zoom-up Towers. Offers quickest, easiest way to make an installation up to 50'. Each section telescopes inside the other—to erect, simply slide out each section in its turn—insert bolt thru section below—tighten to keep mast from turning. Each tower complete with guy runs, bolts, and mounting base suitable for peak or flat roof. Handsome and sturdy. Rocket Zoom-ups offer you economy and long life. Order by size.  
20' ..... \$ 9.95 30' ..... \$15.95  
40' ..... 19.95 50' ..... 29.95  
(Deduct 10% discount in lots of 3)

**National Electronics OF CLEVELAND**  
**THE HOUSE OF TV VALUES**  
6608 Euclid Ave., Dept. N-2, Cleveland 3, O.

**DON'T THROW OLD RADIOS AWAY!**

Here's the data you need to fix them FAST and r-i-g-h-t!

There's a "secret" to repairing old radios fast and profitably... and this big RADIO TROUBLESHOOTER'S HANDBOOK is it!  
Just look up the old make and model you want to fix. This manual-size, 3 1/2 pound, 744-page Ghirardi handbook tells what the trouble is likely to be... and shows you exactly how to fix it. No useless testing! No wasted time! Even beginners can handle jobs "slick as a whistle."

**THE ONLY GUIDE OF ITS KIND!**  
**Cuts service time in half!**

Included are common trouble symptoms and their remedies for over 4,800 models of home and auto radios and record changers. Actual case histories cover practically every model made by 202 manufacturers between 1925 and 1942—Airline, Apex, Arvin, Atwater Kent, Belmont, Bosch, Brunswick, Clarion, Crosley, Emerson, Fada, G-2, Kelsler, Maestri, Motorola, Philco, Pilot, RCA, Silvertone, Sparton, Stromberg and dozens more. Gives how-to-do-it data on SPECIFIC jobs—NOT general theory. Includes hundreds of pages of invaluable tube and component data, service short cuts, etc.

.....**TRY IT 10 DAYS . . . at our risk!**.....

Dept. RN-25, RINEHART & CO., Inc.  
232 Madison Ave., New York 16, N. Y.  
Send Ghirardi's RADIO TROUBLESHOOTER'S HANDBOOK for 10-day free examination. If I decide to keep book, I will then remit the full price of only \$8.50 plus a few cents postage. Otherwise, I will return book postpaid and owe you nothing.  
NAME.....  
ADDRESS.....  
CITY, ZONE, STATE.....

**ELECTRONIC WAR TERMINATION INVENTORY**  
**BIG SAVINGS... UP TO 85%**

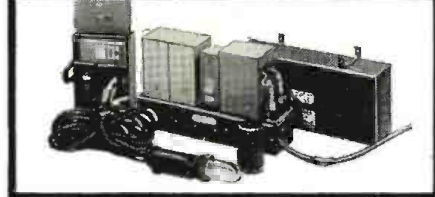

**STROBOSCOPIC LIGHT (100 W. Sec.)**  
For Lab, Testing and Photo Flash

A terrific piece of equipment, excellent for lab work, industrial testing and use in outdoor and studio flash applications. Operates on auto battery or any 6/12 or 12/24 VDC source. Comes complete with ignition coil, trigger housing and strobe light hand ass'y. Includes 20 ft. of cord. Uses Syvl. A-1073 200 WS bulb (similar to Syvl 4330, but has Pyrex shield). Price includes spare parts kit with extra A-1073, spare tubes, fuses and vibrator. BRAND NEW, ready to operate, instruction manual provided. Shipping weight approx. 50 lbs.  
**SPECIAL CLEARANCE PRICE \$25.00**

**RADAR SCOPE INDICATOR**  
Type 1D-11/APS-4

Complete scope indicator unit. Contains 3FP7 tube, and two 6J6 tubes. Equipment totally enclosed by tube shield mounted on chassis. Includes capacitors, scope regulator and 3 ft. Amphenol lead connector.  
**TERMINATION PRICE... \$3.95**

**ENCLOSE CHECK WITH ORDER**  
**PRICES F. O. B. BURBANK, CALIF.**

**cal-tech SALES COMPANY**  
449 S. San Fernando Road • Burbank, Calif.

**"Ultra-Linear" Amplifier**  
(Continued from page 47)

which are not the inherent faults of the circuits, but are due to the fact that the optimum transformer was not used.

In this push-pull parallel design, circuit considerations and transformer design have been integrated to provide a circuit of excellent stability—a circuit in which the feedback could be increased by 6 db without encountering instability either on resistive or speaker load.

However, some combinations of loading can lead to ringing or other transient disturbances under conditions of high level operation. This can be prevented completely by the addition of a 250 μfd. capacitor across one-half of the output transformer primary (from blue-white lead to red lead). The need for this expedient is the exception rather than the rule.

Special circuit considerations such as staggering at the low end and the introduction of local current feedback by splitting the driver stage cathodes in order to increase stability at high frequencies have been incorporated in this design. In addition, the output transformer was designed to have a bandpass flat plus or minus 1 db from 10 cps to 100 kc. with a smooth phase characteristic tailored to the phase characteristic of the amplifier. The transformer, the Acrosound TO-330, also was designed to provide high power at low distortion over a very wide band. The transformer combinations of bandwidth, preservation of operating characteristics at all power levels, and maintenance of push-pull balance over a very wide band all combine with the basic circuit configuration to give good stability and unusually outstanding performance characteristics.

The push-pull parallel circuit provides better results than would be anticipated on the basis of doubling the output stage capabilities. Since the TO-330 transformer is more efficient than the lower powered unit designed for a single pair of output tubes, more than twice as much power is available from the push-pull parallel circuit than from the regular push-pull amplifier using the same design criteria. Thus, it is practical to reach levels in excess of 60 watts before the intermodulation distortion reaches 1 percent—if four normal quality KT66 tubes are used. With selected tubes, the IM can be kept below .5 percent at 60 watts. Conventional commercial advertising of the power capability of the amplifier would classify it as a 65 or 70 watt amplifier with a specification of "peak power in excess of 100 watts."

As with all amplifiers, a mismatch of output impedance such as putting a 64 ohm load on the 16 ohm tap to simulate speaker behavior at the bass resonant frequency results in a decrease of power capability. However, this also results in a decrease in distortion. For



# THE NEW WRENCH WITH THE "INNER GRIP"

WALDEN

# in-a-grip

TRADE MARK

## WRENCHES

PATENTS PENDING

... GRIP and DRIVE ALL HEX HOLLOW-HEAD SET SCREWS AND CAP SCREWS!

NO FUMBLING  
NO DROPPING



OVER 200 TYPES AND SIZES IN STOCK

WRITE FOR CATALOGUE

MANUFACTURED EXCLUSIVELY BY

MAKERS OF SPINTITES, GRIP SPINTITES, — FORCE-FORMED SOCKET WRENCHES — AND ALL TYPES OF MECHANICS' HAND TOOLS FOR OVER 50 YEARS

**STEVENS WALDEN Inc.**  
450 SHREWSBURY STREET  
WORCESTER, MASSACHUSETTS

example, under matched impedance conditions, the IM distortion of one of these amplifiers at 24 watts is .14 per cent (based on a 40 cps and 7 kc. signal mixed 4:1). With the mismatched condition, the total power output is reduced to less than 40 watts, but the IM at 24 watts is .07 per cent—a reduction to one-half. Such low values of distortion exceed the capabilities of most measuring equipment.

The amplifier passes more than 50 watts of power without visible distortion on the scope at any frequency from 20 cps to 30 kc. Frequency response, of course, is far greater than this power curve indicates; and because normal frequency response is plus or minus 1 db from 2 cps to 200 kc., the square wave transmission at any frequency from 20 cps to 20 kc. is excellent.

The amplifier requires only 1.3 volts to drive to full output. This makes it practical for use with any preamplifier, as any commercial unit can supply the necessary signal voltage.

The combination of attributes available in this push-pull parallel design is unique. It offers more power, at lower distortion, over a wider bandpass than can be obtained by any conventional circuits.

It is realized that measured performance does not make an amplifier sound good. Of course, poor measurements generally indicate poor listening quality; but the converse is not true. Therefore, since measurements correlate imperfectly with listening qualities, it is necessary to make the listening test the final and most important test of merit. The performance of the push-pull parallel circuit remains superior on listening also.

Heavy bass passages have better definition and sound better damped on the push-pull parallel amplifier than on others. This is due apparently to more than the additional power capability alone. It seems to be also due to the high damping factor of 16, the fact that varying speaker impedances do not pull the power capability down to below a satisfactory level, and to the fact that distortion is at as low values as have ever been achieved outside the laboratory.

In the middle and upper frequency regions, the absence of intermodulation effects and the undistorted reproduction of transient signals make for a smoothness and clarity which is apparent in less listener fatigue. After continued exposure to the quality of the push-pull parallel circuit, it is difficult to listen to other circuits without becoming aware of their previously unnoticed shortcomings.

### BIBLIOGRAPHY

1. Sarser and Sprinkle, "The Maestro—A Power Amplifier," *Audio Engineering*, November 1952.
2. Williamson, D. T. N., "A High Quality Amplifier Design," *Wireless World*, September 1947.
3. Williamson, D. T. N., "Amplifiers and Superlatives," *Wireless World*, September 1952.
4. Hafer, David, "Improving the Williamson Amplifier," *RADIO & TELEVISION NEWS*, February 1953.

## RADIO ENGINEERING DEGREE IN 27 MONTHS

Radio engineering is a big field. There's room for you in it—if you're good. Get first-class training at Indiana Tech. Intensive, specialized course, including strong basis in mathematics and electrical engineering, advanced radio theory and design, television, electronics, Modern laboratories. Low rate. Also B.S. DEGREE IN 27 MONTHS in Aeronautical, Chemical, Civil, Electrical and Mechanical Engineering. G.I. Government approved. Enter June, September, December, March. You can earn part of your expenses right here in Fort Wayne while you are studying.

### INDIANA TECHNICAL COLLEGE

925 E. Washington Blvd., Fort Wayne 2, Indiana

Please send me free information on B.S. Engineering degree in 27 months as checked.

- Radio-Television     Aeronautical  
 Civil     Mechanical     Electrical

Name .....  
Address .....

### SELECT SURPLUS

Amateur and Industrial Components and Equipment

- RCA MODULATION TRANSFORMER—XT-2974—(6L6 to 807, HV Insul. B. New—450 MA THORDARSON PUV Choke—10 Henry—\$ 2.95
- 10,000 volt insul. B. New..... 9.95
- THERMADOR or SOLA—modulation Xformer—1 kilowatt (SIG. Corps #229634.29) for #047H, 3047L, etc. B. New crated—express or frt. 29.95
- T-23—100-150 MC—arc-5 Xmitter with tubes, xtal. fine condition—while they last..... 19.95
- BC-457—4-5.0MC—New—w/tubes ..... 6.95
- BC-458—5.3-TMC—New—w/tubes ..... 6.95
- BC-459—7.9.1MC—New—w/tubes ..... 14.95
- PACKAGED DEAL FOR THE MAN WHO HAS EVERYTHING . . . 1 each: T-23, BC457, BC458, BC459 ..... 42.50
- KENYON PLATE XFORMER T-664—740-0-740, 150 MHS.—fraction of original cost—B. New 4.95
- KENYON PLATE & FILA. XFORMER—400-0-400, 325MA—5V-6A, 6.3V-6A, \$40.00 list—B. New ..... 6.95
- TUBE TYPE 3AS—ULIF twin triode—B. New RCA orig. box. . . . . 3 for \$1.00; dz. 3.75
- IN22—gen'l purp. diode—Sylvania—clipped leads—guaranteed ..... 1.00
- IN22—gen'l purp. diode—V.E.—boxed—lead jacket ..... 1.00

### REX RADIO SUPPLY

a good place to buy  
88 Cortlandt St., New York 7, N. Y.

## HIGHER POWER—HIGHER FIDELITY



\$169.50 net

Full descriptive data available on request

**Sonex, Inc.**  
245 Sansom St., Upper Darby, Pa.

## Sonex 60 WATT ULTRA-LINEAR AMPLIFIER

- 60 watts at less than 1% IM
- 10 watts at less than .1% IM
- Response ± 1 db 2 cps to 200 kc
- Damping factor 16
- Acrosound TO-330 transformer

A combination integrated for the finest possible sound

### Ultra-Linear Pre-amplifier

- Less than .05% IM distortion
- Response ± 1 db 10 cps to 100 kc
- All feedback design with step controls
- Engineered for maximum flexibility

\$99.50